

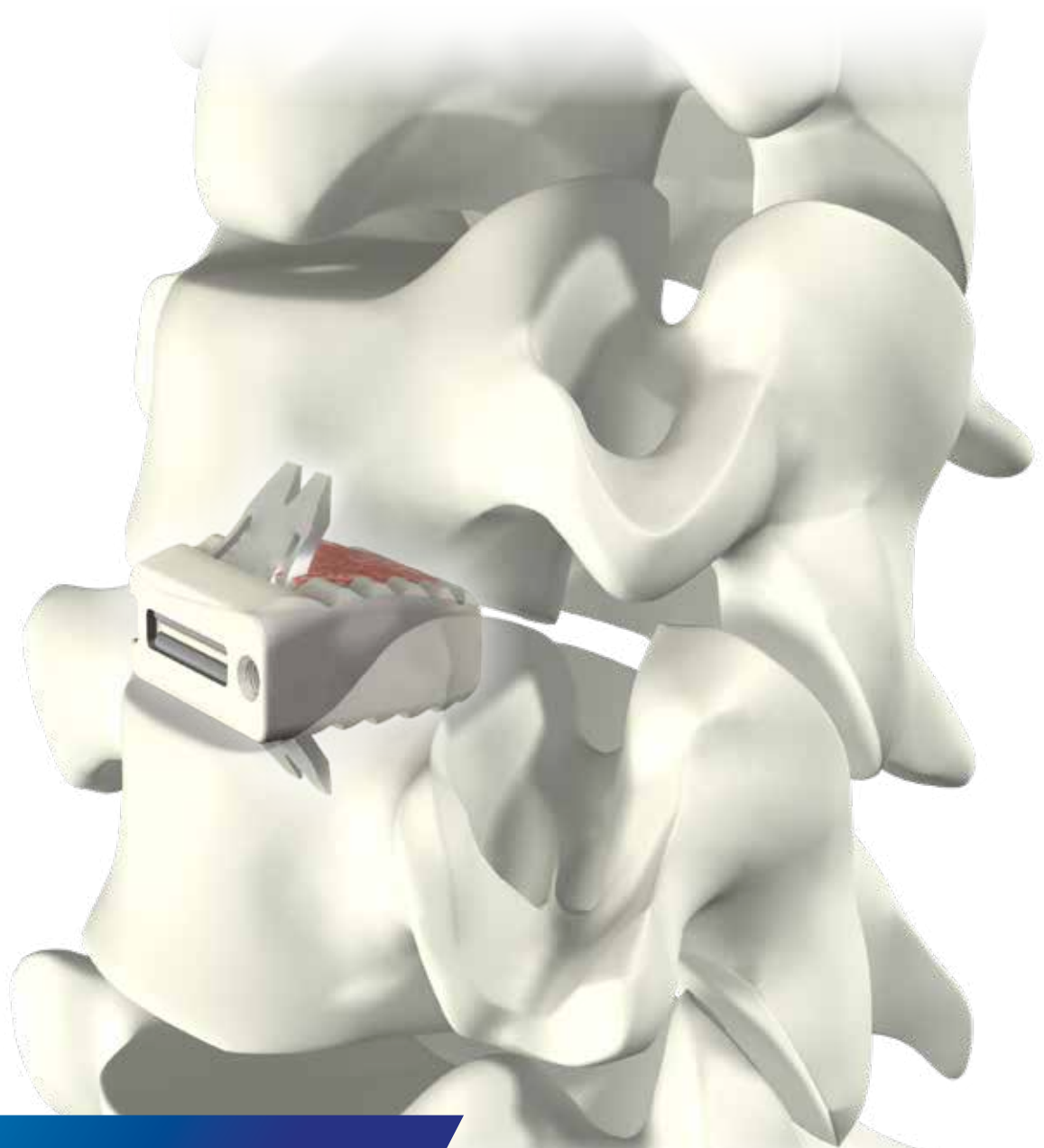

ZIMMER BIOMET

Your progress. Our promise.®



Cervical Solutions

# ROI-C® Cervical Cage



Surgical Technique Guide

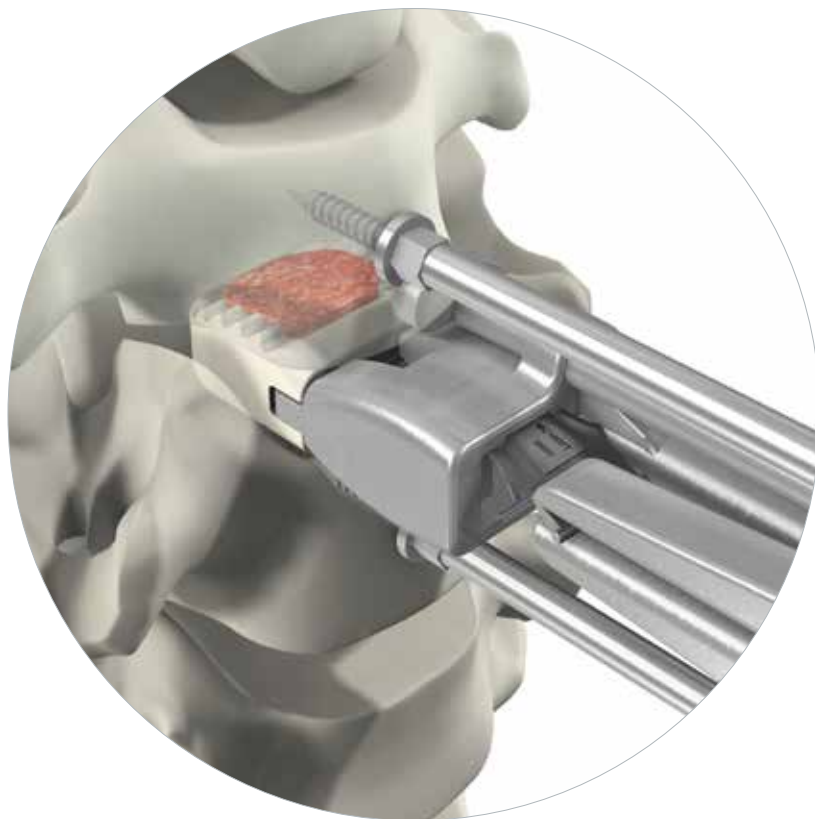

*ROI-C featuring VerteBRIDGE plating is a zero-profile, stand-alone\* cervical cage, with streamlined instrumentation and surgical technique, requiring minimal exposure.*

*\* In case of trauma, vertebral instability, or significant bone removal, the ROI-C implant should be augmented with additional supplemental fixation.*

## TABLE OF CONTENTS

ROI-C Cervical Cage Overview	4
Preparation and Access	5
Distraction and Discectomy	6
Trialing	7
Implant Insertion	
Depth Stop Selection	9
Implant Holder Components	9
Implant Holder Assembly	10
Implant Connection to Implant Holder	10
Implant Positioning	11
Plate Insertion	
(Optional) Starter Awl Selection	12
(Optional) Starter Awl Assembly	12
(Optional) Starter Awl Insertion	13
VerteBRIDGE Plate Selection	14
Plate Reference Table	14
First Plate Insertion	15
(Optional) Second Starter Awl Insertion	17
Second Plate Insertion	19
Implant Holder Removal and Final Assessment	20
Implant Revision	21
Implant Kit	24
Starter Awl Plate and VerteBRIDGE Reference Tables	25
Instrument Set	26
Important Information on the ROI-C Cervical Cage	28

*Zimmer Biomet Spine does not practice medicine. This technique was developed in conjunction with health care professionals. This document is intended for surgeons and is not intended for laypersons. Each surgeon should exercise his or her own independent judgment in the diagnosis and treatment of an individual patient, and this information does not purport to replace the comprehensive training surgeons have received. As with all surgical procedures, the technique used in each case will depend on the surgeon's medical judgment as the best treatment for each patient. Results will vary based on health, weight, activity and other variables. Not all patients are candidates for this product and/or procedure.*

## ROI-C CERVICAL CAGE OVERVIEW

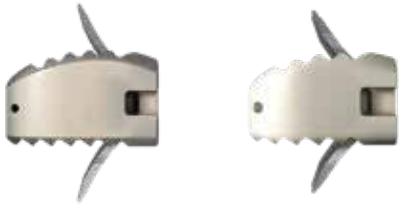

### Anatomic

Features a superior edge that complements healthy endplate contours.

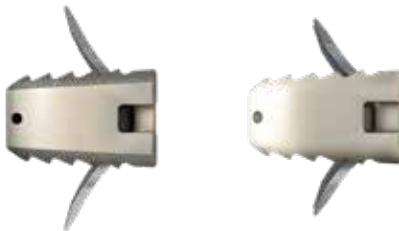

### Lordotic

Designed to allow close contact with the bone of patients with flattened endplates.

The ROI-C Cervical Cage with VerteBRIDGE plating offers a sleek and minimalistic stand-alone\* solution. Streamlined instrumentation functions in-line with the disc space, requiring minimal exposure, while an innovative implant design leaves minimal hardware in the patient, all without sacrificing stability.

\* In cases of trauma, vertebral instability, or significant bone removal, the ROI-C implant should be augmented with additional supplemental fixation.

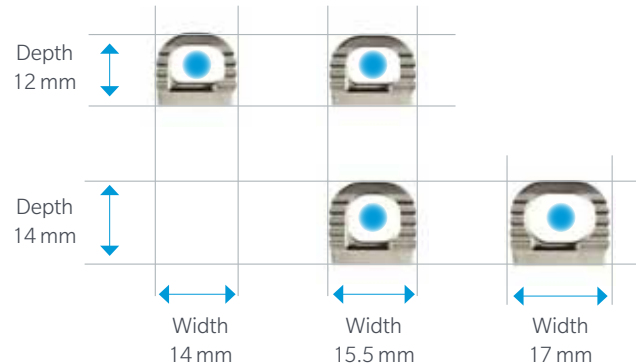

### 4 Footprints

Broad offering to adapt to various patient anatomies.

The ROI-C Cervical Cage is available in a variety of footprints designed to meet varying patient anatomies. The cage accommodates integrated, self-guided, self-locking VerteBRIDGE plating designed to provide stability with no instrumentation protruding anterior of the vertebral bodies. The self-guided, curved VerteBRIDGE plates are delivered in the plane of the disc through a direct anterior approach, so that the surgery can be achieved with less exposure than may be required to implant a traditional cervical plate, or even contemporary stand-alone systems with screws that must be inserted at oblique and challenging angles.

The system features thoughtfully designed instrumentation including an inserter that protects anatomical structures when placing the cage and VerteBRIDGE plating.

## PREPARATION AND ACCESS

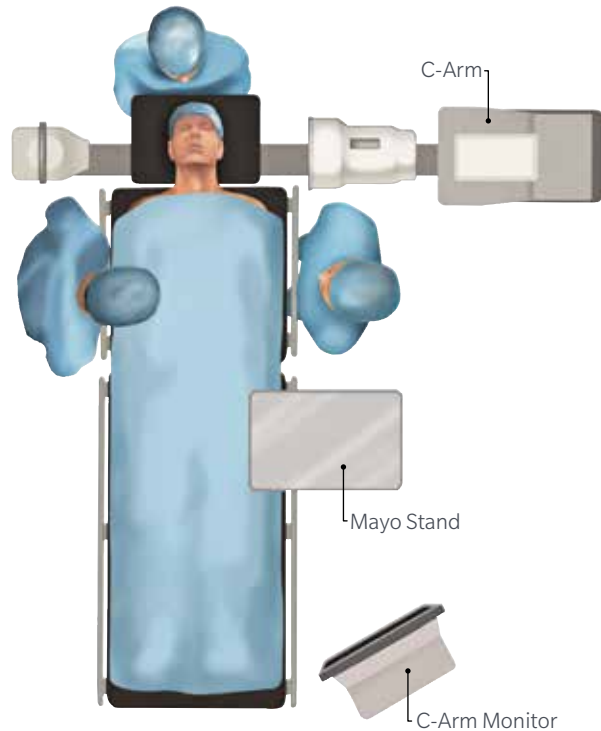
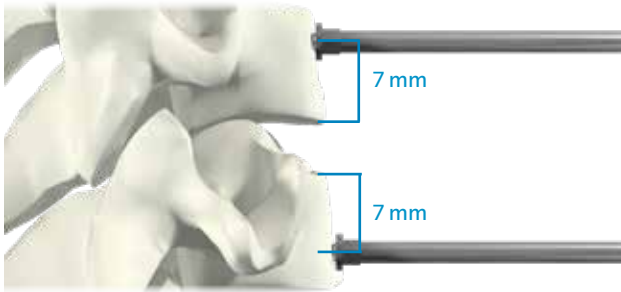

**Figure 1**  
*Patient positioning*

### STEP 1

- Review and inspect all instrumentation and implants prior to sterilization.
- Replace or add any necessary components for the planned surgery.
- Surgeon must be fully experienced with the required spinal fusion techniques.
- Position and drape the patient in the usual fashion (Figure 1).
- Expose the affected levels via a standard incision and tissue dissection.
- Place any retraction pins in locations that will allow for the planned implant and instrumentation.
- Perform any necessary bone and tissue removal.
- Prepare vertebral endplates via the use of a combination of curettes, rasps, osteotomes, disc shavers or rongeurs to remove disc material and cartilage.

## DISTRACTION AND DISCECTOMY



**Figure 2**  
Caspar distractor

### STEP 2

Perform a thorough discectomy to remove the disc down to the osseous endplates. Prepare the endplates just enough to create a surface that will encourage vascularization between the endplates and the graft without weakening cortical bone.

After the discectomy, distract as necessary to achieve adequate access to the disc space.

If using a caspar distractor, the pins should be placed approximately 7 mm from both endplates to avoid contact between the caspar pins and ROI-C anchoring plates during insertion (Figure 2).

If patient anatomy doesn't allow 7 mm of space, then remove the caspar pins prior to plate advancement to eliminate any risk of plate obstruction.



**Figure 3a**  
Anatomic cage



**Figure 3b**  
Lordotic cage

During the discectomy, consider the two available implant profiles:

- **ROI-C Anatomic:** Designed with a curved superior surface that compliments healthy endplate contours. The anatomic implant has a 6° of built-in lordosis. ROI-C anatomic's design is available in both PEEK OPTIMA® and titanium coated (Figure 3a).
- **ROI-C Lordotic:** Features a tapered profile for patients with flattened endplates. The lordotic implant has 7° of built-in lordosis. ROI-C lordotic's design is available in both PEEK OPTIMA® and titanium coated (Figure 3b).

## TRIALING



**Figure 4**  
Depth gauge measurement: 14 mm

## STEP 3

### Depth Assessment

Place the hook of the depth gauge (MB906R) just over the posterior edge of the inferior vertebra.

To achieve the most accurate reading, position the depth gauge as medial as possible and completely remove all anterior and posterior osteophytes.

- View the depth reading at the end of the depth gauge and determine if the 12 mm or 14 mm depth implant will provide a more optimal fit (Figure 4).

Using fluoroscopy, estimate the footprint and height to best choose a trial. A trial can be placed in front of the space to visually determine width. (Reference the tables on page 24 for depth, width, and height combinations.)



**Figure 5**  
Trial

Trialing should begin with (Figure 5):

- The selection of implant profile: anatomic or lordotic.
- A conservative height not to exceed the height of healthy adjacent discs.
- A width that should extend to the uncinat processes, but should not ride up onto either uncus.
- A depth that leaves 1 mm of space from the anterior and posterior vertebral borders.

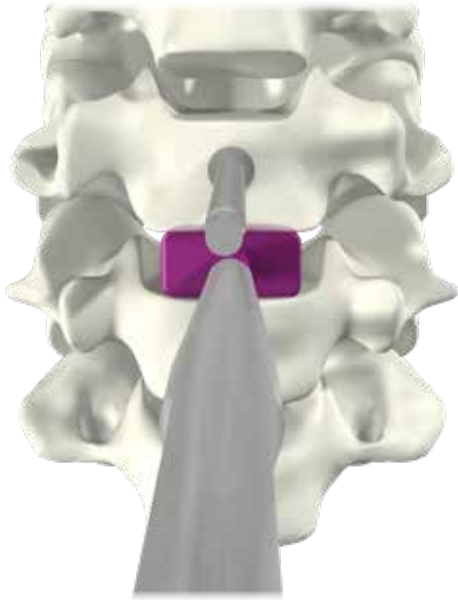

**Figure 6a**  
Trial insertion

The ROI-C trials:

- Should provide optimal endplate coverage, height restoration, and good segmental stability (Figure 6a).
- Represent the dimensions of the implants.
- Are color coded by footprint size to match the implant packaging's color dot on the end of the box.

Insert the selected trial into the space. Use lateral radiographic imaging to confirm trial sizing (Figure 6b).

Release the distraction in order to best assess the disc space height and restore the best anatomic shape of the operated space, as well as the best stability to the implant.

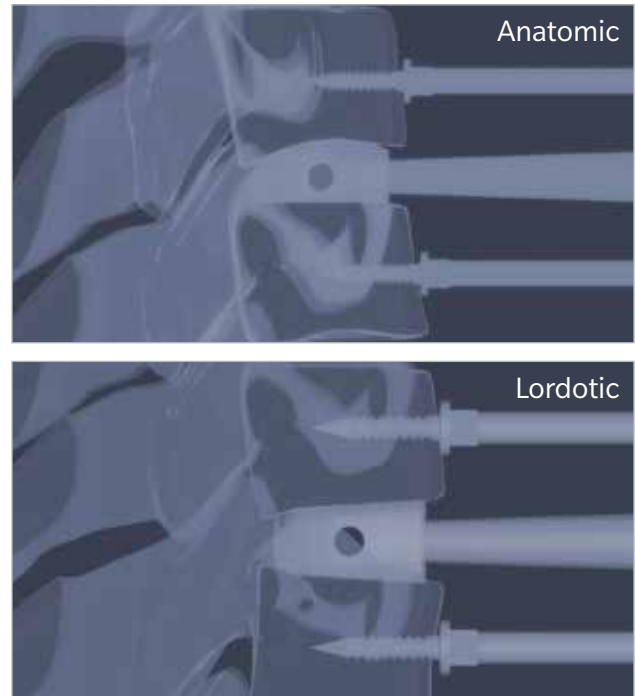

**Figure 6b**  
Lateral radiographic imaging

**Note:** Without distraction, the trial should be snug in the disc space even as the trial's integrated handle is gently pulled away directly anterior from the vertebrae to assess fit.

**Note:** Radiographic imaging is mandatory to confirm sizing. The hole through the trial should appear circular. An oval shape indicates possible rotation.

**Note:** ROI-C trials are available with depth stops upon surgeon request.



## IMPLANT INSERTION



SMALL DEPTH STOP



LARGE DEPTH STOP



U-SHAPED DEPTH STOP

**Figure 7a**  
Depth stops sizes

### STEP 4

#### Depth Stop Selection (Figure 7a)

The ROI-C system offers three depth stops:

- Small Depth Stop (MC9001R-3)
  - width 5 mm x height 3.72 mm
- Large Depth Stop (MC9004R)
  - width 8.2 mm x height 4 mm
- U-Shaped Depth Stop (SI-ROIC-0063)
  - width 14.41 mm x height 6.35 mm



INNER THREADED ROD



IMPLANT HOLDER



DEPTH STOP

THUMB WHEEL

**Figure 7b**  
Implant holder components

#### Implant Holder Components (Figure 7b)

- Inner Threaded Rod (MC9001R-2)
- Implant Holder Body (MC9091R-1)
- Thumb Wheel (MC9001R-4)
- Depth Stop (Large shown here)

## IMPLANT INSERTION (continued)

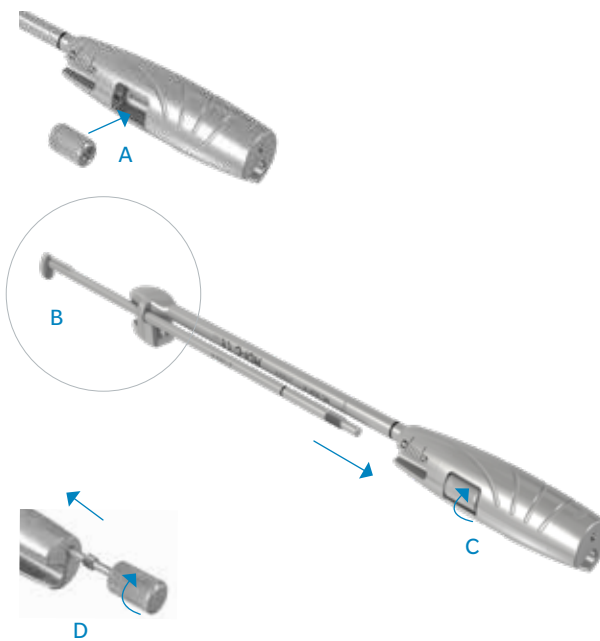

**Figure 8a**  
Implant holder assembly

### Implant Holder Assembly (Figure 8a)

1. Load the thumb wheel (A) into the pocket on the inserter body. Hold thumb over wheel to maintain position.
2. Slide the depth stop through the arch at the distal tip of the inserter (B) and into the thumb wheel. Capture the depth stop by rotating the thumb wheel clockwise (C), and adjust to 0.
3. Load the threaded rod into the cannula of the inserter through the handle (D) and rotate clockwise to securely capture.

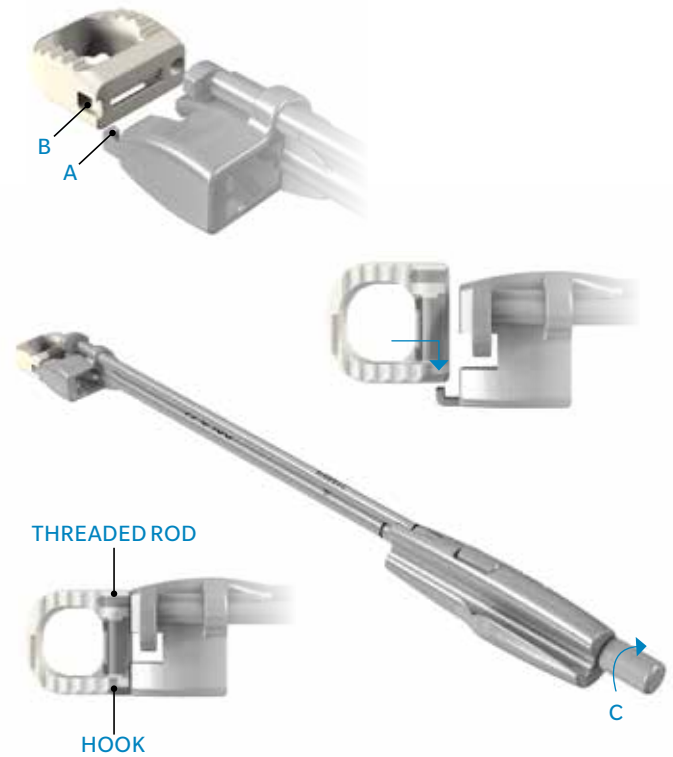
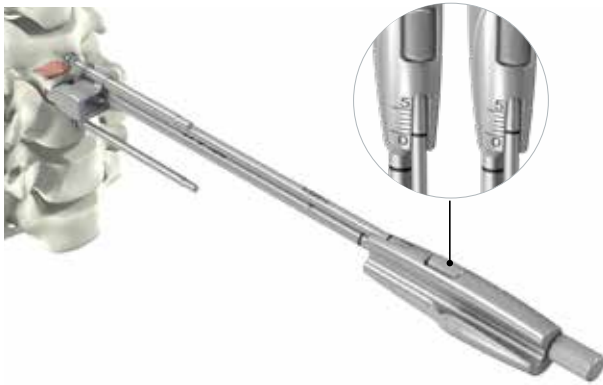

**Figure 8b**  
Implant connection to implant holder

### Implant Connection to Implant Holder (Figure 8b)

- Connect the selected implant to the implant holder by engaging the hook (A) on the holder with the slot (B) on the side of the implant.
- Once the hook is fully engaged, screw the knob (C) on the end of the holder to secure the implant with the threaded rod.
- The connection is fully secure when there is:
  - No toggle in the connection.
  - No gap visible between the knob and the handle.
- Load the central space of the implant with graft.

**Note:** Overtightening of the threaded rod on the implant could strip the PEEK threads and weaken the implant to holder connection.

**Figure 8c**

*As needed, change the depth stop setting by 1 mm increments*

### Implant Positioning

- Start by setting the depth stop on the implant holder to 0 mm. When the stop is set to 0 mm, the implant will be recessed from the anterior aspect of the vertebral body by **1 mm** into the disc space (Figure 8c).
- Insert the implant into the disc space by gently tapping on the end of the implant holder. Try to keep the implant holder at a 90° angle to the disc space during insertion.

**Figure 8d**

*Radiographic imaging is mandatory prior to plate insertion*

- As needed, change the depth stop setting by 1 mm increments for posterior adjustment, by turning the knurled wheel clockwise.
- Radiographic imaging is mandatory and should be used to make a final assessment of the implant depth and endplate coverage, prior to plate insertion. A tantalum marker is located 1 mm from the posterior implant edge for positioning reference (Figure 8d).

## PLATE INSERTION

STEP 1



STEP 2



STEP 3



STEP 4



STEP 5



STEP 6



STEP 7

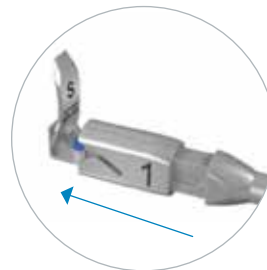

STEP 8

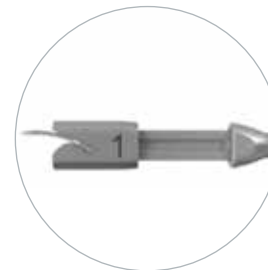

**Figure 9a**  
Starter awl assembly

**Figure 9b**  
Starter awl assembly so that the blue retaining pin and sliding metal encasement labeled with a #1 are oriented upwards

### STEP 5

#### Starter Awl Selection — Optional

- The starter awl impactor (MC9097R) may be used especially when sclerotic bone is detected. With the cage in the final position, the awl may be used to initiate the path for the VerteBRIDGE plates.
- The starter awl impactor works with two different sizes of sterile-packed starter awl plates, selected based on the height of the implant. **Starter awl plates are not intended for implantation and should be properly disposed of following surgery.**
  - Short (MC9095R-S) for implants with 5-7 mm heights
  - Long (MC9096R-S) for implants with 8-10 mm heights

#### Starter Awl Assembly — Optional

- Choose the proper starter awl plate size, and remove it from its packaging. Position the starter awl impactor so that both the blue retaining pin and sliding metal encasement labeled with a #1 are oriented upwards. Grasping the starter awl plate by the silicone protective cap, fasten it to the distal end of the starter awl impactor in the orientation depicted in (Figure 9a).
- Pull the starter awl plate distally to the end of the starter awl impactor as depicted below, and remove the silicone cap. Slide the encasement forwards so that the starter awl plate fits snugly into place (Figure 9b).

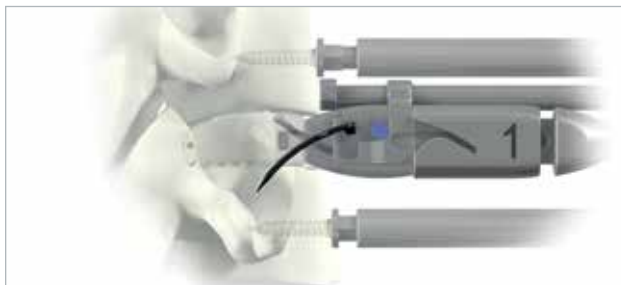
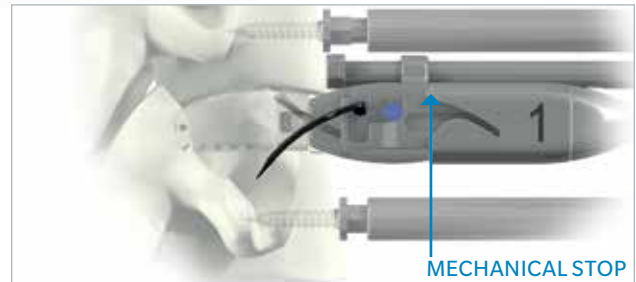
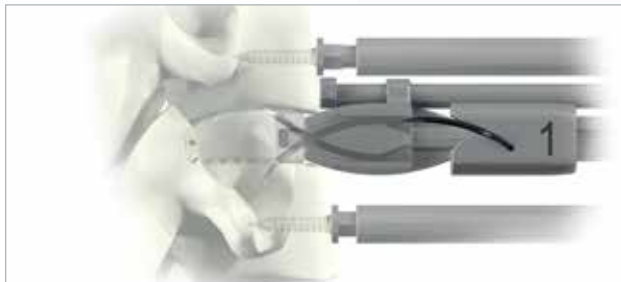

**Figure 9c**  
Insertion

**Figure 9d**  
Validate final starter awl plate position

### Starter Awl Insertion — Optional

- Insert the shaft of the starter awl impactor into the ROI-C implant holder's groove. Orient the #1 on the encasement so that it is visible, opposite of the body of the ROI-C implant holder (**Figure 9c**). ROI-C starter awls are never to be used with ROI-C plate impactors (MC9092R & MC9093R).

**Important:** If the pins appear to be positioned where they could possibly impede the starter awl plates, remove the distractor and caspar pins before insertion.

- Insert the starter awl plate into the superior slot of the ROI-C implant holder head. If resistance is felt during insertion into the slot, remove the starter awl plate and repeat the step. Use thumb pressure to bring the starter awl plate into contact with the bone. Start the insertion with three to four mallet impactions on the proximal end of the starter awl impactor or until the starter awl plate is inserted roughly 50% of the way into the vertebral body.

- Extract the starter awl plate partially by reverse impaction on the distal end of the impactation knob. Repeat impaction until the starter awl plate is 100% within the vertebral body, indicated by a full mechanical stop from the ROI-C implant holder, as depicted above. Validate plate position radiographically (**Figure 9d**) and remove the starter awl plate through reverse impaction on the starter awl impactor knob.

**Important:** It is important to prepare the second vertebral body with the starter awl plate only after insertion of the first ROI-C locking plate. The pathway in the second vertebral body must not be prepared at the same time as the pathway in the first vertebral body.

PLATE INSERTION (continued)

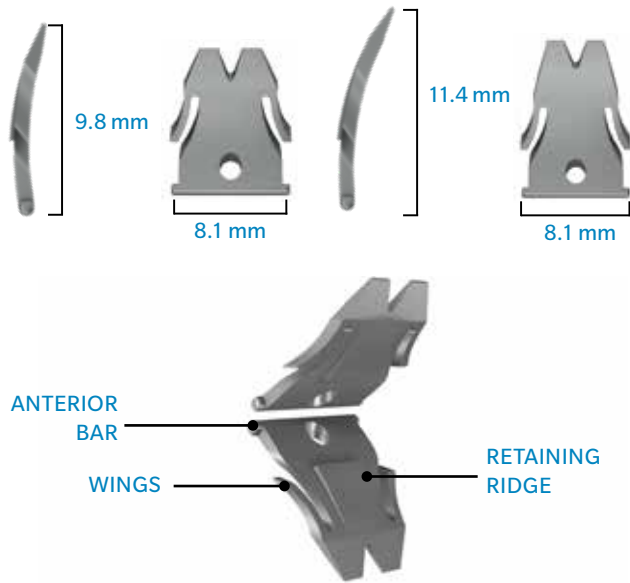

Figure 10  
Plate selection

VerteBRIDGE Plate Selection

- Select the plate length according to the height of the implant being used. Use the ROI-C standard plate (MC1005T) with heights 5-7 mm and the ROI-C long plate (MC1006T) with 8-10 mm heights.

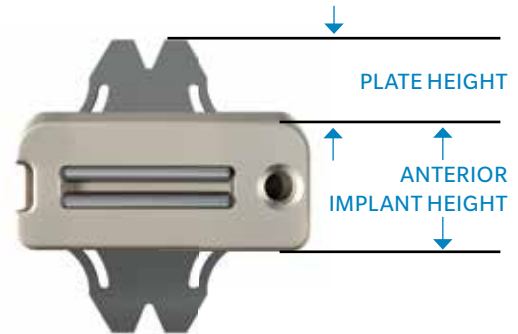

Figure 11  
Plate reference

Anatomic Plate Reference Table

Implant Height (mm)	Plate Size (Reference Number)	Plate Height (mm)
H5		5.5
H6	Standard MC1005T	5.0
H7		4.5
H8	Long MC1006T	5.6

Lordotic Plate Reference Table

Implant Height (mm)	Plate Size (Reference Number)	Plate Height (mm)
H5		5.7
H6	Standard MC1005T	5.3
H7		4.8
H8		5.9
H9	Long MC1006T	5.4
H10		4.9

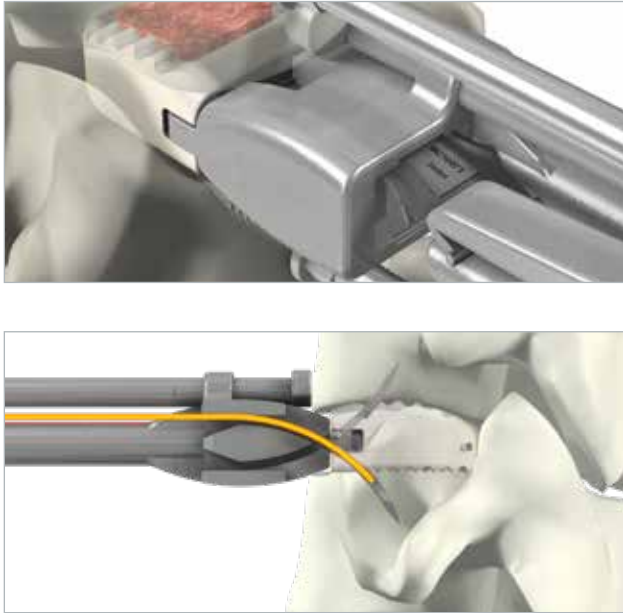
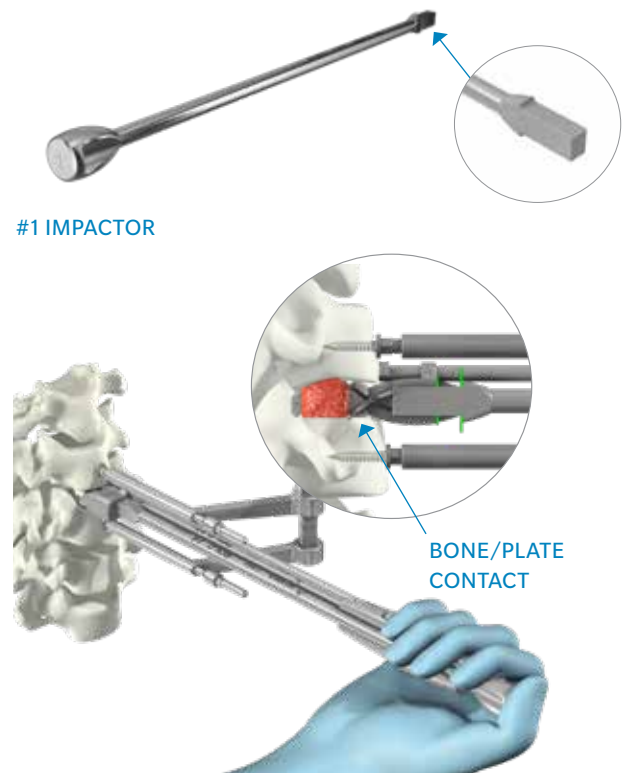

**Figure 12**  
Load first plate

### First Plate Insertion— Load First Plate

- Prior to inserting the first plate, release the distractor and caspar pins (if used), to allow compression of the construct.
- With the implant in the final position, load the first plate into the cranial slot of the implant holder using the plate holder (MC901R). The plate paths cross within the implant holder so the plate inserted into the cranial slot will be advanced into the caudal vertebral body (Figure 12).

**Note:** The plates may be inserted into the cranial or caudal slot for the first plate.



**Figure 13**  
Advance first plate

### Advance First Plate

- Using thumb pressure, insert the #1 impactor (MC9092R) to advance the first plate until it touches bone (Figure 13). Take a lateral radiographic image to verify the plate is touching the bone.

**Note:** If the plate does not advance with thumb pressure, confirm the plate is properly loaded in the holder and that the holder is aligned with the PEEK.

## PLATE INSERTION (continued)

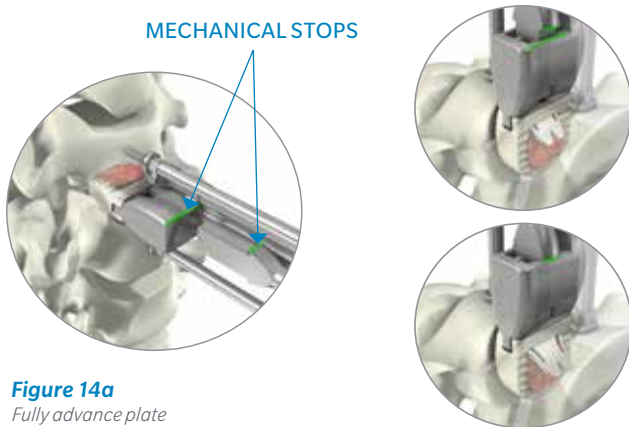

**Figure 14a**  
Fully advance plate

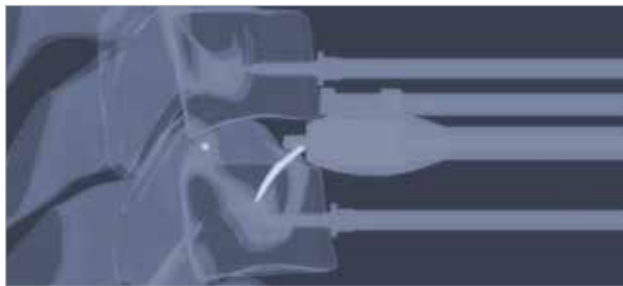

**Figure 14b**  
Fully advance plate

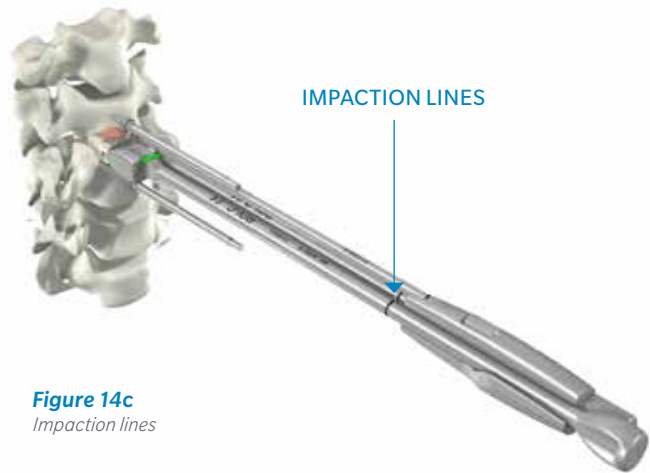

**Figure 14c**  
Impaction lines

### Advance First Plate (continued)

- Use a mallet to impact the first plate into the bone. The plate is fully advanced when the mechanical stop on the impactor meets the mechanical stop of the implant holder (Figure 14a).
- Do not proceed to the #2 impactor until proper placement of the implant and first plate are confirmed via fluoroscopy or x-ray (Figure 14b).

**Note:** The impaction lines (Figure 14c) will allow visualization of the plate’s advancement and the mechanical stops should make contact when the lines appear aligned.

### Finalize First Plate Position

- Once position is confirmed, use the #2 impactor (MC9093R) to finalize the advancement of the first plate. Again, the plate will have advanced completely when the mechanical stop on the #2 impactor meets the mechanical stop on the implant holder.
- Take a lateral radiographic image to ensure proper implant and plate position.

**Note:** The plates must be advanced and finalized using this sequence:

1st Plate	2nd Plate
Advance with thumb pressure	Advance with thumb pressure
#1 Impactor	#1 Impactor
#2 Impactor	#2 Impactor



## ROI-C SECOND STARTER AWL IMPACTOR

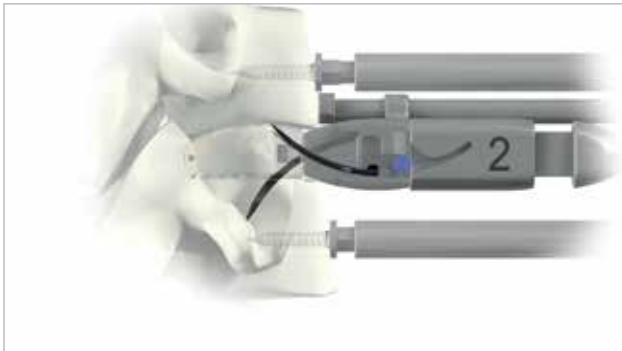
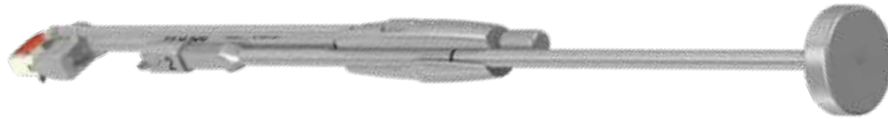

**Figure 15a**  
Second starter awl insertion

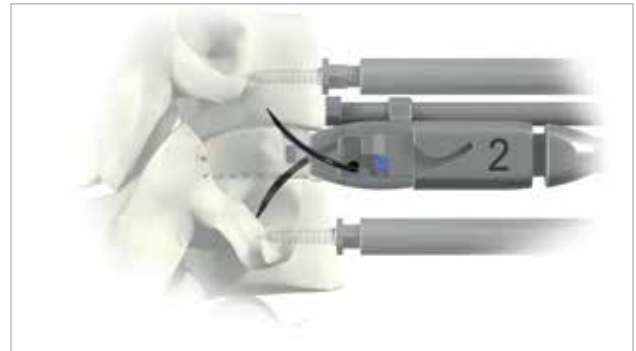
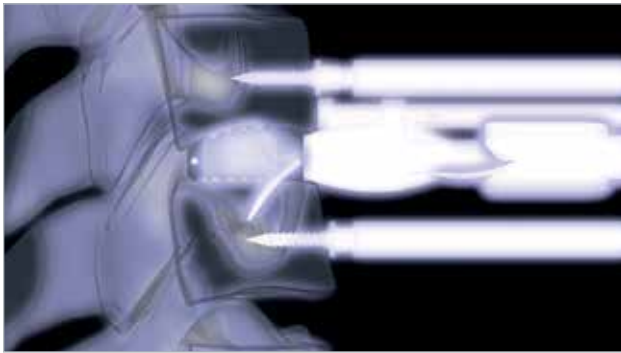
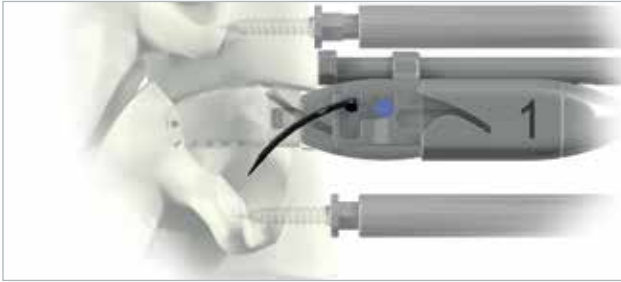

**Figure 15b**  
Second starter awl is roughly 50% into the vertebral body

### Second Starter Awl Insertion— Optional

- After full insertion of the first ROI-C locking plate, inspect the ROI-C starter awl plate for any damage and begin preparation of the second vertebral body in the same way as the first.
- Position the awl impactor already loaded with the starter awl plate so that the blue retaining pin is oriented downwards and sliding encasement labeled with a #2 faces outward (**Figure 15a**). Ensure that the starter awl plate is pulled distally to the end of the starter awl impactor and slide the encasement forwards so that the starter awl plate fits snugly into place.
- Insert the shaft of the starter awl impactor into the ROI-C implant holder's groove as shown. Orient the #2 on the encasement so that it is visible, opposite of the body of the ROI-C implant holder.
- Insert the starter awl plate into the inferior slot of the ROI-C implant holder head. If resistance is felt during insertion into the slot, remove the starter awl plate and repeat the step. Use thumb pressure to bring the starter awl plate into contact with the bone. Start the insertion with three to four mallet impactions on the proximal end of the starter awl impactor, or until the starter awl plate is inserted roughly 50% of the way into the vertebral body (**Figure 15b**).

## PLATE INSERTION (continued)



**Figure 15c**  
Second starter awl is roughly 100% into the vertebral body

### Second Starter Awl Insertion— Optional (continued)

- Extract the starter awl plate partially by reverse impaction on the distal end of the impaction knob. Repeat impaction until the starter awl plate is 100% within the vertebral body, indicated by a full mechanical stop from the ROI-C implant holder, as depicted above. Validate plate position radiographically and remove the starter awl plate through reverse impaction on the starter awl impactor knob. Starter awl plates are not intended for implantation and should be disposed of following use (Figure 15c).

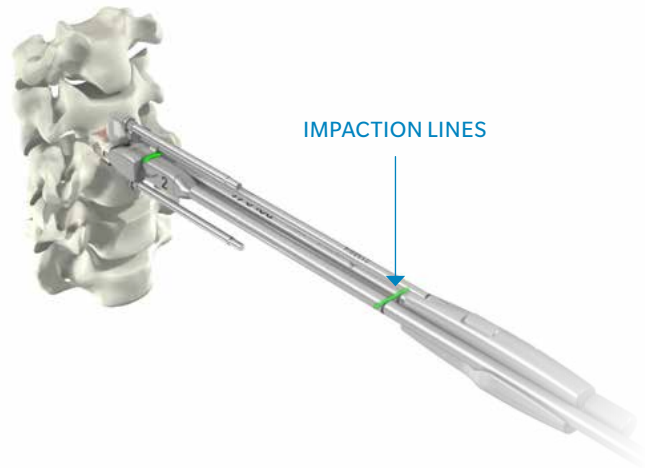

**Figure 15d**  
Impaction lines

**Note:** The impaction lines will allow visualization of the plate's advancement and the mechanical stops should make contact when the lines appear aligned (Figure 15d).

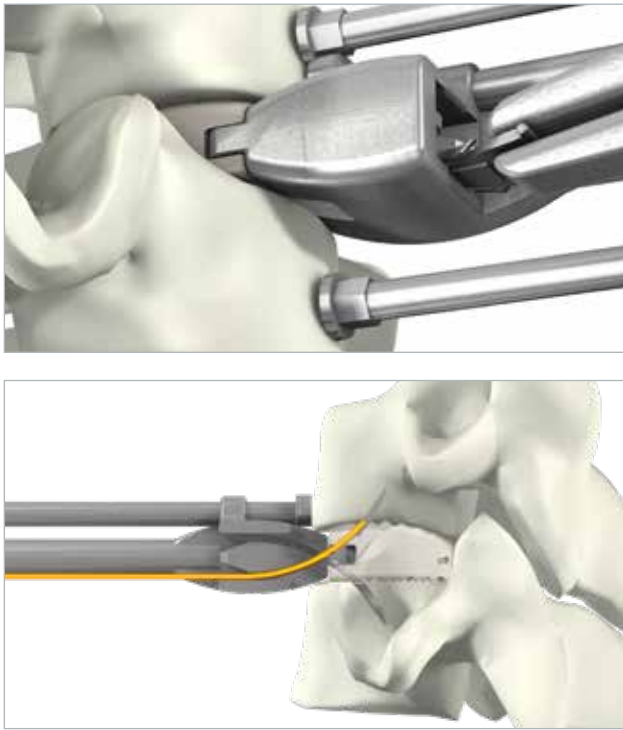

**Figure 16**  
*Second plate insertion*

### Second Plate Insertion — Load Second Plate

- Confirm that the knob on end of implant holder is fully tightened. Insert the second plate into the caudal slot of the implant holder (or the cranial slot if the first plate was inserted into the caudal slot) (Figure 16).
- The second plate can only be inserted after the first plate is fully advanced.

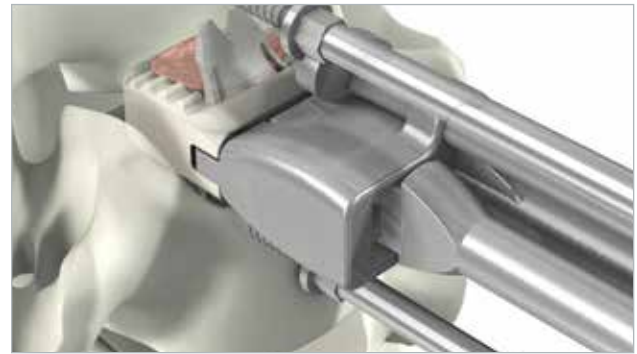
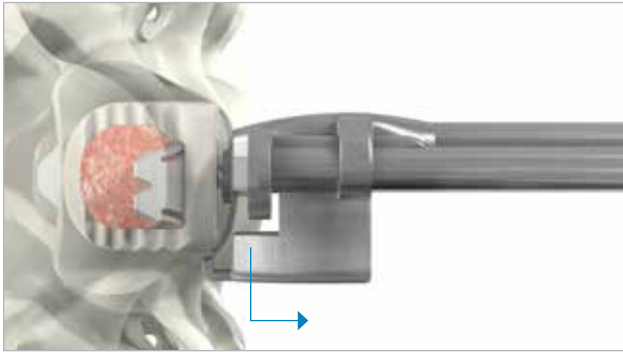

**Figure 17**  
*Advance and finalize second plate*

### Advance and Finalize Second Plate

- Using the same plate advancement and confirmation technique, apply thumb pressure on the #1 impactor to advance the second plate until it touches bone. Then mallet the #1 impactor to insert the second plate into the bone.
- Confirm position under radiographic imaging, then use the #2 impactor to finish advancing the plate (Figure 17). The plate is fully advanced when the mechanical stop on the impactor meets the mechanical stop of the implant holder.

## PLATE INSERTION (continued)



**Figure 18**  
Implant holder removal

### Implant Holder Removal

- Remove the implant holder by turning the knob on the end of the holder counter-clockwise until the threads disengage and the inner threaded rod can be removed from the inserter. Slide the holder to the left releasing the hook from the slot in the implant before removing the holder from the wound (Figure 18).



**Figure 19**  
Radiographic imaging

### Final Fluoroscopy or X-ray of Proper Placement

- Confirm proper placement with radiographic imaging (Figure 19).

**Note:** In cases of vertebral instability or significant bone removal the ROI-C implant with VerteBRIDGE plating should be augmented with additional supplemental fixation.

## IMPLANT REVISION



**Figure 20a**  
Step 1

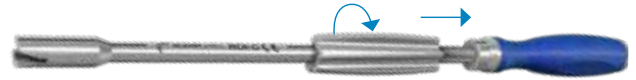

**Figure 20c**  
Step 3

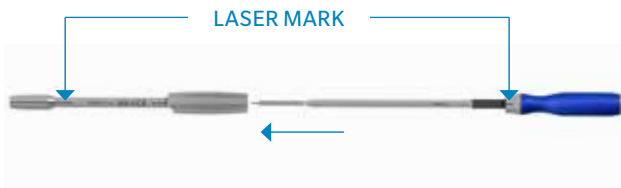

**Figure 20b**  
Step 2



**Figure 20d**  
Assembled plate removal instrument

### Assemble Revision Instrument

- Insert the knob onto the sleeve of the revision instrument (MC9089R) (Figure 20a).
- Orient the black line on the distal end of the sleeve with the black line on the handle. With this orientation, the top or opening of the hook is visible. Then, insert the hook into the sleeve of the removal instrument (Figure 20b).

- Rotate the knob counter-clockwise until it stops against the handle (Figure 20c).
- The assembled plate removal instrument is shown here (Figure 20d).

## IMPLANT REVISION (continued)

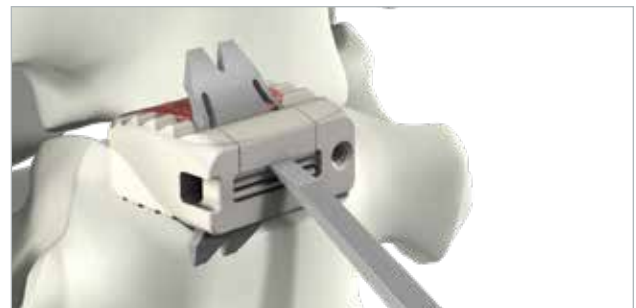
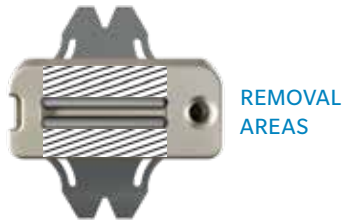
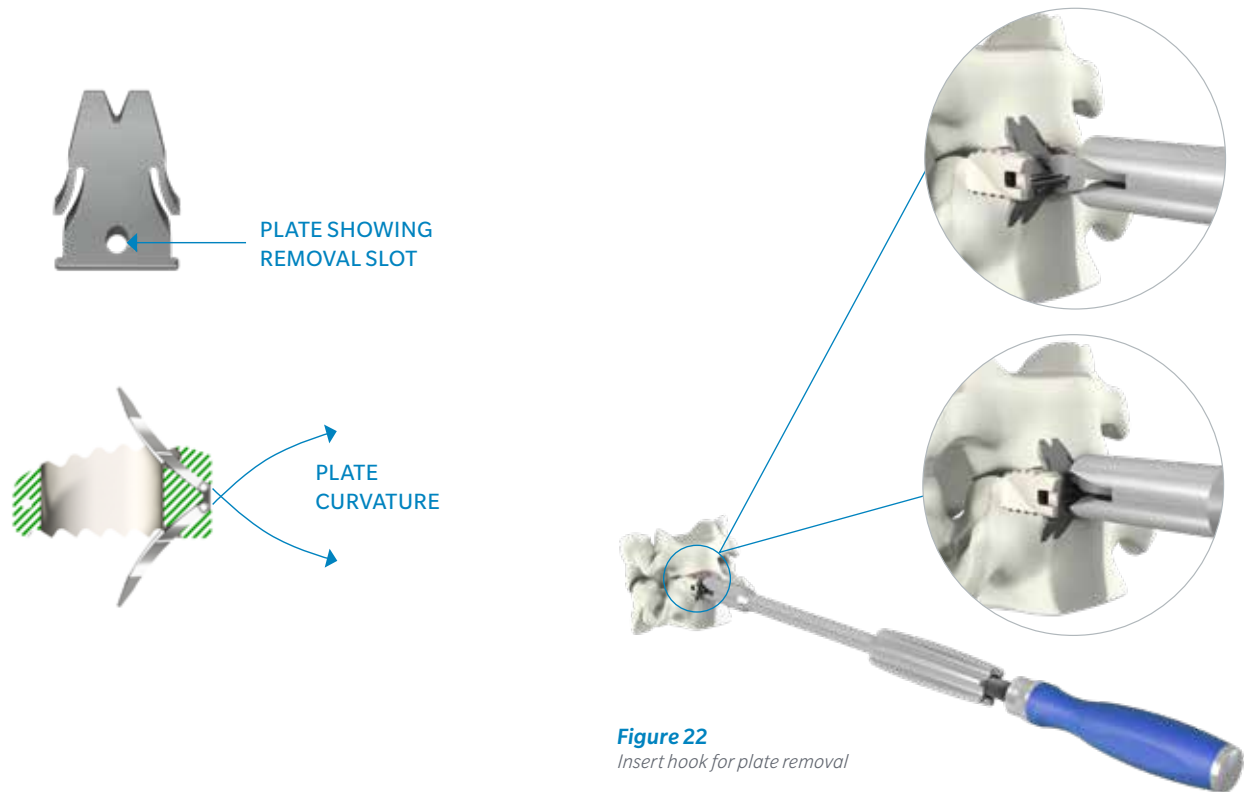

**Figure 21**  
Removal of PEEK to access plate

### Plate Removal

- Start the explant process with the removal of the two plates. To remove the plates, portions of the anterior face of the PEEK implant must be removed. The diagonal stripes show the PEEK that must be removed to expose the plates.
- Under irrigation, use a burr to create a notch on each side of the plate, weakening the PEEK for removal (Figure 21).
- Use a pick-up to remove loose pieces of PEEK. The osteotome (MC9088R) can also be used to break and release any remnant PEEK pieces.
- Repeat these steps to remove the PEEK in front of the second plate.

**Note:** An osteotome may be used instead of the burr for PEEK removal.



**Figure 22**  
Insert hook for plate removal

### Plate Removal (continued)

- Insert the hook of the plate removal instrument in the plate hole (Figure 22).
- Advance the sleeve of the removal instrument to the anterior face of the vertebrae by turning the knob of the removal instrument clockwise.
- Lock the hook on the plate and continue turning the knob clockwise to remove the plate from the cage.
- Turn the instrument 180° such that the hook is positioned to grasp the second plate, and repeat these steps to extract the second plate.

### Implant Removal

- A Kocher may be used or the implant holder attached to remove the implant anteriorly. If the implant cannot be easily removed, a Cobb elevator or osteotome may be used to loosen the bone to implant interface.

**Note:** The plate removal instrument should be disassembled before being placed in the tray for sterilization following the steps on page 21 in reverse order.

## IMPLANT KIT

### Anatomic

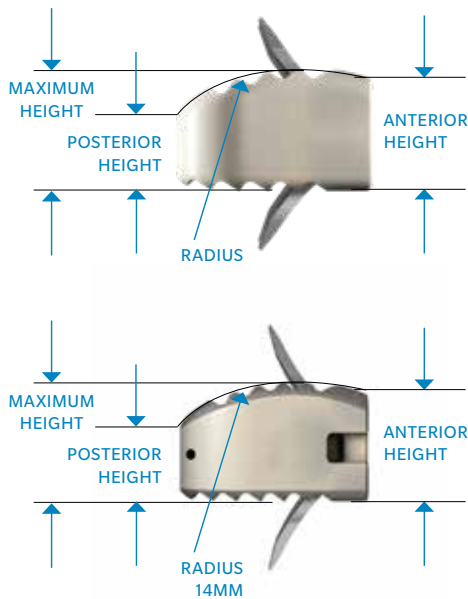

DEPTHxWIDTH (MM)	ANTERIOR HEIGHT	MAXIMUM HEIGHT	POSTERIOR HEIGHT	GRAFT VOLUME (CC)	PART NUMBER	TITANIUM COATED
12x14, H5	5	5.5	3	0.31	MC 1341 P	CMC 1341 P
12x14, H6	6	6.5	4	0.36	MC 1342 P	CMC 1342 P
12x14, H7	7	7.5	5	0.41	MC 1343 P	CMC 1343 P
12x14, H8	8	8.5	6	0.45	MC 1344 P	CMC 1344 P
12x15.5, H5	5	5.5	3	0.31	MC 1351 P	CMC 1351 P
12x15.5, H6	6	6.5	4	0.36	MC 1352 P	CMC 1352 P
12x15.5, H7	7	7.5	5	0.41	MC 1353 P	CMC 1353 P
12x15.5, H8	8	8.5	6	0.45	MC 1354 P	CMC 1354 P
14x15.5, H5	5	5.9	3	0.42	MC 1321 P	CMC 1321 P
14x15.5, H6	6	6.9	4	0.48	MC 1322 P	CMC 1322 P
14x15.5, H7	7	7.9	5	0.54	MC 1323 P	CMC 1323 P
14x15.5, H8	8	8.9	6	0.60	MC 1324 P	CMC 1324 P
14x17, H5	5	5.9	3	0.51	MC 1331 P	CMC 1331 P
14x17, H6	6	6.9	4	0.60	MC 1332 P	CMC 1332 P
14x17, H7	7	7.9	5	0.67	MC 1333 P	CMC 1333 P
14x17, H8	8	8.9	6	0.75	MC 1334 P	CMC 1334 P

### Lordotic

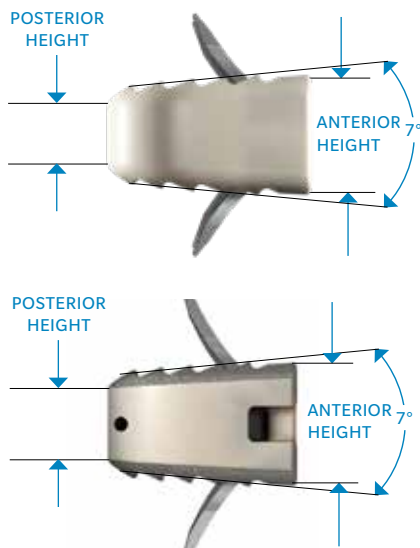

DEPTHxWIDTH (MM)	ANTERIOR HEIGHT	POSTERIOR HEIGHT	GRAFT VOLUME (CC)	PART NUMBER	TITANIUM COATED
12x14, H5	5	2.3	0.30	MC 1441 P	CMC 1441 P
12x14, H6	6	3.1	0.35	MC 1442 P	CMC 1442 P
12x14, H7	7	4.1	0.41	MC 1443 P	CMC 1443 P
12x14, H8	8	5.1	0.47	MC 1444 P	CMC 1444 P
12x14, H9	9	6.1	0.53	MC 1445 P	CMC 1445 P
12x14, H10	10	7.1	0.59	MC 1446 P	CMC 1446 P
12x15.5, H5	5	2.3	0.30	MC 1451 P	CMC 1451 P
12x15.5, H6	6	3.1	0.35	MC 1452 P	CMC 1452 P
12x15.5, H7	7	4.1	0.41	MC 1453 P	CMC 1453 P
12x15.5, H8	8	5.1	0.47	MC 1454 P	CMC 1454 P
12x15.5, H9	9	6.1	0.53	MC 1455 P	CMC 1455 P
12x15.5, H10	10	7.1	0.59	MC 1456 P	CMC 1456 P
14x15.5, H5	5	2.4	0.36	MC 1421 P	CMC 1421 P
14x15.5, H6	6	3.2	0.42	MC 1422 P	CMC 1422 P
14x15.5, H7	7	4.2	0.49	MC 1423 P	CMC 1423 P
14x15.5, H8	8	5.2	0.57	MC 1424 P	CMC 1424 P
14x15.5, H9	9	6.2	0.64	MC 1425 P	CMC 1425 P
14x15.5, H10	10	7.2	0.72	MC 1426 P	CMC 1426 P
14x17, H5	5	2.4	0.44	MC 1431 P	CMC 1431 P
14x17, H6	6	3.2	0.52	MC 1432 P	CMC 1432 P
14x17, H7	7	4.2	0.61	MC 1433 P	CMC 1433 P
14x17, H8	8	5.2	0.71	MC 1434 P	CMC 1434 P
14x17, H9	9	6.2	0.80	MC 1435 P	CMC 1435 P
14x17, H10	10	7.2	0.89	MC 1436 P	CMC 1436 P



## STARTER AWL PLATE AND VERTEBRIDGE REFERENCE TABLES

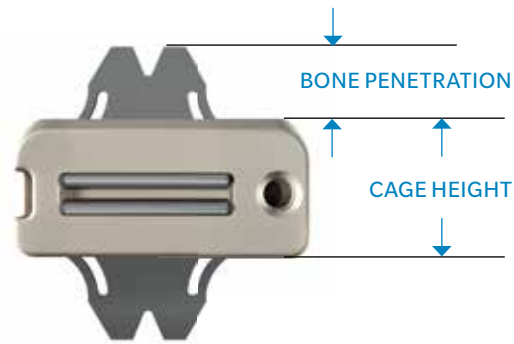

## Anatomic

Starter Awl Plate			ROI-C VerteBRIDGE Plate		
CAGE HEIGHT	SIZE	BONE PENETRATION (MM)	PART NUMBER	BONE PENETRATION (MM)	PENETRATION DIFFERENCE (MM)
H5		5.2		5.5	0.3
H6	Short MC9095R-S	4.7	Short MC1005T	5.0	0.3
H7		4.2		4.5	0.3
H8	Long MC9096R-S	5.3	Long MC1006T	5.6	0.3

## Lordotic

Starter Awl Plate			ROI-C VerteBRIDGE Plate		
CAGE HEIGHT	SIZE	BONE PENETRATION (MM)	PART NUMBER	BONE PENETRATION (MM)	PENETRATION DIFFERENCE (MM)
H5		5.4		5.7	0.3
H6	Short MC9095R-S	5.0	Short MC1005T	5.3	0.3
H7		4.5		4.8	0.3
H8		5.6		5.9	0.3
H9	Long MC9096R-S	5.1	Long MC1006T	5.4	0.3
H10		4.6		4.9	0.3

## INSTRUMENT SET

Top Tray

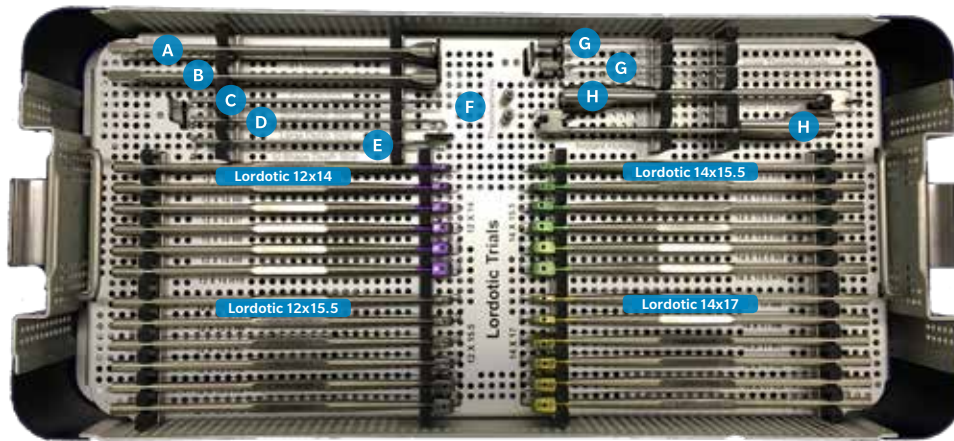

Bottom Tray

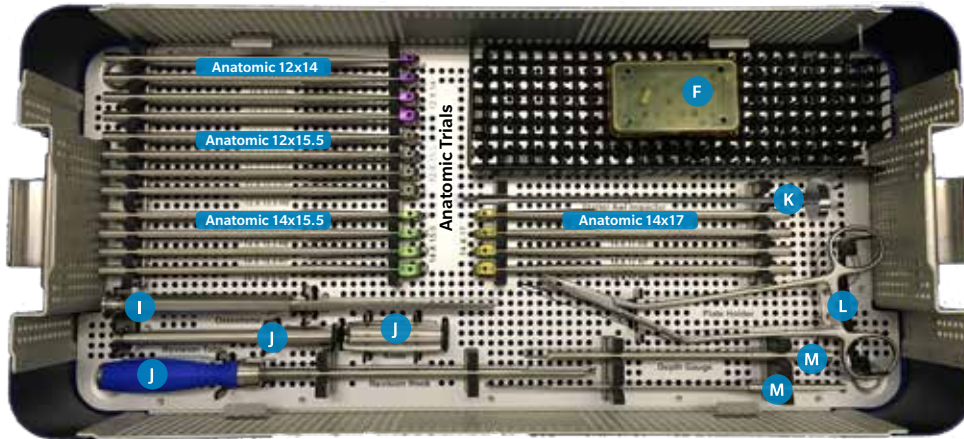

**IMPACTOR #1**

PART NUMBER

A

MC9092R



**IMPACTOR #2**

PART NUMBER

B

MC9093R



**SMALL DEPTH STOP**

PART NUMBER

C

MC9001R-3



**LARGE DEPTH STOP**

PART NUMBER

D

MC9004R



**U-SHAPED DEPTH STOP**

PART NUMBER

E

SI-ROIC-0063



**THUMB WHEEL**

PART NUMBER

F

MC9001R-4



INNER THREADED ROD	PART NUMBER
G	MC9001R-2



IMPLANT HOLDER	PART NUMBER
H	MC9091R-1



OSTEOTOME	PART NUMBER
I	MC9088R



PLATE REMOVAL INSTRUMENT	PART NUMBER
J	MC9089R



STARTER AWL IMPACTOR	PART NUMBER
K	MC9097R



PLATE HOLDER	PART NUMBER
L	MC901R



DEPTH GAUGE	PART NUMBER
M	MB906R



LORDOTIC TRIALS (TOP TRAY)	PART NUMBER
12 x 14, H5	MC9100R
12 x 14, H6	MC9101R
12 x 14, H7	MC9102R
12 x 14, H8	MC9103R
12 x 14, H9	MC9104R
12 x 14, H10	MC9105R
12 x 15.5, H5	MC9106R
12 x 15.5, H6	MC9107R
12 x 15.5, H7	MC9108R
12 x 15.5, H8	MC9109R
12 x 15.5, H9	MC9110R
12 x 15.5, H10	MC9111R
14 x 15.5, H5	MC9118R
14 x 15.5, H6	MC9119R
14 x 15.5, H7	MC9120R
14 x 15.5, H8	MC9121R
14 x 15.5, H9	MC9122R
14 x 15.5, H10	MC9123R
14 x 17, H5	MC9124R
14 x 17, H6	MC9125R
14 x 17, H7	MC9126R
14 x 17, H8	MC9127R
14 x 17, H9	MC9128R
14 x 17, H10	MC9129R

ANATOMIC TRIALS (BOTTOM TRAY)	PART NUMBER
12x14 H5	MC9011R
12x14 H6	MC9012R
12x14 H7	MC9013R
12x14 H8	MC9014R
12x15.5 H5	MC9018R
12x15.5 H6	MC9019R
12x15.5 H7	MC9020R
12x15.5 H8	MC9021R
14x15.5 H5	MC9032R
14x15.5 H6	MC9033R
14x15.5 H7	MC9034R
14x15.5 H8	MC9035R
14x17 H5	MC9039R
14x17 H6	MC9040R
14x17 H7	MC9041R
14x17 H8	MC9042R

## IMPORTANT INFORMATION ON THE ROI-C CERVICAL CAGE

### Device Description

The ROI-C Implant System ROI-C Titanium- Coated Implant System consist of 'D' shaped blocks in a variety of footprints and heights. The lordotic shape of the ROI-C Lordotic Implants & ROI-C Lordotic Titanium-Coated Implants allow for optimum surface area contact with vertebrae that embody a flat surface morphology. The curved shape of the ROI-C Anatomic Implants & ROI-C Anatomic Titanium-Coated Implants allow for optimum surface area contact with vertebrae that embody a curved surface morphology. The ROI-C Implant System & ROI-C Titanium-Coated Implant System are offered in a closed graft space design. The implants feature an enclosed chamber intended to be filled with autologous or allogenic bone graft composed of cancellous and/or corticocancellous bone graft. The superior and inferior surfaces of the implants have a pattern of teeth to provide increased stability and to help prevent movement of the device.

The ROI-C Titanium-Coated Implant System offers a porous plasma sprayed Titanium Coating of superior and inferior surfaces of the implants.

The ROI-C Implant System & ROI-C Coated Implant System are intended to be implanted singularly via an anterior approach and is intended to be used with autologous bone graft. The devices must be used with supplemental internal fixation. The ROI-C Implant System & ROI-C Titanium-Coated Implant System have been designed to be compatible with optional supplemental fixation specific for the system. The two piece VerteBRIDGE Anchoring Plate is available and may be used to affix the ROI-C Implant System & ROI-C Titanium-Coated Implant System implants to the underlying vertebral bone, and to specifically allow for the option of a standalone construct. Additional or other supplemental fixation may be used, as patient needs dictate.

### Indications for Use

The ROI-C Implant System & ROI-C Titanium- Coated Implant System are indicated for use in skeletally mature patients with degenerative disc disease (DDD) of the cervical spine with accompanying radicular symptoms at one disc level from C2–T1. DDD is defined as discogenic pain with degeneration of the disc confirmed by history and radiographic studies. These patients should have had six weeks of nonoperative treatment. The ROI-C Implant System & ROI-C Coated Implant System implants are to be used with autogenous or allogenic bone graft composed of cancellous and/or corticocancellous bone graft and implanted via an open, anterior approach. Supplemental internal fixation is required to properly utilize this system.

### Contraindications

Contraindications include, but are not limited to:

- Presence of fever or acute, chronic, systemic, or localized infection.
- Metal sensitivity or allergies to the implant materials, documented or suspected.
- Severe osteopenia.
- Pregnancy.
- Prior fusion at the level(s) to be treated.
- Patients unwilling or unable to follow post-operative care instructions.
- Other medical risks, anesthetics risks, or surgical conditions which would preclude the potential benefit of spinal implant surgery.
- Any condition not described in the indications for use.

### Potential Side Effects

The list of side effects below is not exhaustive. The listed side effects are possible side effects known to potentially occur for procedures that may involve this type of device and surgical approach. These side effects can sometimes necessitate further surgical treatment.

- Fissure or fracture of implant components;
- Loss of fixation, dislocation and/or migration;

- Neurological complication, paralysis, soft tissue lesions, pain due to the surgical procedure, and/or breakage deformation;
- Injury to vessels, nerves and organs;
- Neurological and spinal dura matter lesions from surgical trauma;
- Superficial or deep-set infection and inflammatory phenomena;
- Venous thrombosis, pulmonary embolism and cardiac arrest;
- Hematoma and impaired wound healing.

LDR SPINE USA cannot be held responsible for any complications arising from: incorrect diagnosis, choice of incorrect implants or operating techniques, limitations of treatment methods, inadequate asepsis, any change in the product after delivery, incorrect handling before, during and after the surgery.

New side effect from materiovigilance MAUDE: Electric Arc with a bovie.

### Warnings

- Risks associated with general surgery, orthopedic surgery, and the use of general anesthesia should be explained to the patient prior to surgery. It is also recommended that the advantages and disadvantages of surgery, the implants, as well as alternative treatment methods be explained to the patient.
- Potential risks associated with the use of this system, which may require additional surgery, include device component failure (bending, loosening or fracture), loss of fixation, non-union, fracture of the vertebra, neurological injury, vascular or visceral injury, neurological complications, over-distraction, trauma to nerve root or dura, incorrect implant positioning, implant migration, pseudoarthrosis, disc height loss (impaction of implant into vertebral end plates), allergy or inflammation, general adverse effects related to surgical procedures (e.g. anesthesia, infection), subsidence, expulsion.
- The device can break if it is subjected to increased loading associated with delayed union or non-union. If healing is delayed or does not occur, the implant could eventually break due to material fatigue. Factors such as the patient weight, activity level, and compliance to weight bearing or load bearing instructions, have an effect in the stresses to which the implant may be subjected, and may affect the longevity of the implant.
- Patients with previous spinal surgery at the level(s) to be treated may have different clinical outcomes compared to those without a previous surgery.
- Discard all damaged or mishandled implants.
- Under no circumstances may the implants be re-used. Although the device may appear intact on removal, internal modification due to the stress and strains placed on it, or small defects may exist which may lead to fracture of the implant.
- Implants removed from a patient that contact bodily tissues or fluids should never be reused at risk of contamination of the patient.
- Mixing Metal: Some degree of corrosion occurs on all implanted metal and alloys. Contact of dissimilar metals (e.g. stainless steels and titanium), however, may accelerate this corrosion process. The presence of corrosion may accelerate fatigue fracture of implants and the amount of metal compounds released into the body system may also increase. Internal fixation devices such as rods, connectors, screws, hooks, etc, which come into contact with other metal objects must be made from like or compatible metals. This is an important consideration when using supplemental fixation, as required by the indications for use of the System.
- Because different manufacturers employ different materials, varying tolerances, manufacturing specifications, and differing design parameters, components of the ROI-C Implant System & ROI-C Titanium-Coated Implant System should not be used in conjunction with components from any other manufacturer's implant systems. Any such use will negate the responsibility of Zimmer Biomet Spine (formerly LDR Spine USA) for the performance of the resulting mixed component implant.



## IMPORTANT INFORMATION ON THE ROI-C CERVICAL CAGE (continued)

- Any decision by a surgeon to remove the implanted device should take into consideration such factors as the risk to the patient of the additional surgical procedure as well as the difficulty of removal.
- Implant removal should be followed by adequate postoperative management to avoid fracture.

### Precautions

- Being a technically demanding procedure presenting a risk of serious injury to the patient, the implantation of intervertebral body fusion devices or partial vertebral body replacement devices should be performed only by experienced spine surgeons with specific training in the use of this system and who have knowledge of the present instruction for use.
- The surgeon should consider the location of implantation, the weight of the patient, the patient's activity level or general conditions and any other factor which may have an impact on the performance of the system.
- Patients who smoke have been shown to have an increased risk of non-unions. Such patients should be advised of this fact and warned of the potential consequences.
- If the patient is involved in an occupation or activity which applies inordinate stress upon the implant (e.g., substantial walking, running, lifting of significant loads, or muscle strain), resultant forces can cause failure of the device.
- In some cases, progression of degenerative disease may also be so advanced at the time of implantation that they may substantially decrease the expected useful life to the device. In such cases, orthopedic devices may be considered only as a delaying technique or to provide temporary relief.
- Before clinical use, the surgeon should thoroughly understand all aspects of the surgical procedure and limitations of the system. This device is recommended for use only by surgeons familiar with preoperative and surgical techniques, cautions and potential risks associated with such spinal surgery. Knowledge of surgical techniques, proper reduction, selection and placement of implants, and pre and post-operative patient management are considerations essential to a successful surgical outcome.
- Patients should be instructed in detail about the limitations of the implants, including but not limited to the impact of excessive loading through patient weight or activity, and should be taught to govern their activities accordingly.
- Appropriate selection, placement and fixation of the spinal system components are critical factors which affect implant service life. Accordingly, strict adherence to the indications, contraindications, precautions, and warnings for this product is essential to potentially maximize service life. (Note: While proper implant selection can minimize risks, the size and shape of human bones present limitations on the size, shape, and strength of implants.)
- Supplemental internal fixation is required when using the ROI -C Implant System & ROI-C Titanium-Coated Implant System. The two piece VerteBRIDGE Anchor Plate system is available for use with the ROI-C Implant System & ROI-C Titanium-Coated Implant System, and is the supplemental fixation available for use in situations where a stand-alone construct is appropriate. The system may be augmented with additional supplemental fixation as needed and determined by the user. The instructions for use for any additional supplemental fixation system(s) should be followed according to the manufacturer's guidelines.
- Care must be taken to protect the components from being marred, nicked or notched as a result of a contact with metal or abrasive objects. Alterations will produce defects in surface finish and internal stresses which may become the focal point for eventual breakage of the implant.
- Inspection and trial assembly are recommended prior to surgery to determine if the instruments have been damaged during storage or prior procedures.
- Sale of this product is restricted to physicians.

### MRI Safety Information



Non-clinical testing has demonstrated that the Interbody Cage Systems are MR-Conditional. Patients can be scanned safely immediately after implantation under the following conditions:

- Static magnetic field of 1.5 Tesla (1.5T) or 3.0-Tesla (3.0T) only.
- Maximum spatial gradient field of 3000 G/cm (30 T/m) or less.
- Normal Operating Mode: Maximum whole-body specific absorption rate (SAR) of 3.2-3.5 W/kg for 1.5 T systems and 3.2-3.6 W/kg for 3 T systems.
- When other methods of supplemental fixation are used, also follow the MR conditional labeling for the additional components.

Under the scan conditions defined above, the ROI-C Implant System is expected to produce a maximum temperature rise of less than 1°C after 15 minutes of continuous scanning.

In non-clinical testing, the image artifact caused by the device extends approximately 0.8 cm from the ROI-C Implant when imaged with a gradient echo pulse sequence in either a 1.5T or a 3T MRI system.

**Disclaimer:** This document is intended exclusively for physicians and is not intended for laypersons. Information on the products and procedures contained in this document is of a general nature and does not represent and does not constitute medical advice or recommendations. Because this information does not purport to constitute any diagnostic or therapeutic statement with regard to any individual medical case, each patient must be examined and advised individually, and this document does not replace the need for such examination and/or advice in whole or in part.



**Caution:** Federal (USA) law restricts this device to sale by or on the order of a physician. Rx Only. Please see the product Instructions for Use for a complete listing of the indications, contraindications, precautions, warnings and adverse effects.



**Manufactured by:**

LDR Medical  
Parc d'entreprises du Grand Troyes  
Quartier Europe de l'Ouest  
5, rue de Berlin  
10300 Sainte-Savine France  
+33 (0)3 25 82 32 63

**Distributed by:**

LDR Spine  
13785 Research Boulevard, Suite 200  
Austin, TX 78750 USA  
+ 1 512.344.3333



**ZIMMER BIOMET**  
Your progress. Our promise.®

800.447.3625 / [zimmerbiomet.com](http://zimmerbiomet.com)

©2018 Zimmer Biomet Spine, Inc. All rights reserved.

All content herein is protected by copyright, trademarks and other intellectual property rights owned by or licensed to Zimmer Biomet Spine, Inc. or one of its affiliates unless otherwise indicated, and must not be redistributed, duplicated or disclosed, in whole or in part, without the express written consent of Zimmer Biomet Spine. This material is intended for health care professionals and the Zimmer Biomet Spine sales force. Distribution to any other recipient is prohibited.

PEEK OPTIMA is a trademark of Invivio Biomaterial Solutions.

1991.1-US-en-Rev0518